

5 Channel Multifunctional PWM Controller

HomLiCon LCH5T

Application

- Control of groups LED and LED strips
- Control of relays, small motors, fans, etc.
- Control models

Technical Specifications

Number of Channels	5
Color organ number of channels	4 + Inverse Channel
Supply voltage	9 – 28 V DC
Maximum output current per channel	4 A
Maximum total output current	20 A
PWM steps for each channel	110
Number of stored levels and settings	10
Color Organ bandwidth:	LF 50–200Hz , MLF 200Hz–1kHz , MHF 1–7kHz, HF 7–12kHz
Line-in Nominal level	0.3 V RMS
Line-in Maximum level	1.5 V RMS
Mic-in range of sound level (with an added module MACL - not included in the kit)	60 - 120 dB (with additional module) ⁽¹⁾
Current consumption	15 mA
Ambient temperature	5 – 40°C

Controller Features

- ✓ Managing all settings and functions with the remote control included in the kit.
- ✓ Switch with a press of a button between the previously saved custom 10 groups, different levels for all channels or Light Show settings.
- ✓ Easy save of 10 custom groups, different levels for all channels or Light Show settings.
- ✓ Activation of Light Show controlled by sound from microphone⁽¹⁾, Line-in or unsynchronized.
- ✓ Fully automatic Color Organ with digital division of the bandwidth in 4 range:
LF 50 - 200Hz , MLF 200Hz - 1kHz , MHF 1 - 7kHz, HF 7 - 12kHz.
- ✓ Level Meter with / without AGC (Automatic gain control).
- ✓ Automatic or manual switching between different programs of Light Show.
- ✓ Adjust sensitivity AGC (Automatic gain control) for Color Organ separately for each frequency channel LF, MLF, MHF, HF in 4 levels, saved separately for each audio input.
- ✓ Equalize or adjust the light intensity for channels in Light Show.
- ✓ Setting the maximum level for inverse channel in Light Show.
- ✓ Gradual increase or decrease of the intensity of the light when you turn on or off each PWM channel.

- ✓ Gradual increase or decrease of the intensity of light for all channels to reach the preset levels when selecting one of the ten preset functions.
- ✓ Ability to set PWM control for each channel or ON/OFF option.
- ✓ Ability to choose if the channels are off or a saved function is activated when the supply voltage is applied.
- ✓ LED on each one of the channels connected to the microcontroller pins for indication and diagnostics.
- ✓ Power MOSFET for the output of each channel.

1.0 Wiring diagram and description

The supply voltage (9 – 20V DC) is connected to the terminal blocks marked + and - .
All + LED Strip / Module are connected together to the terminal blocks marked + L , and all - LED Strip / Module, respectively to terminals 1, 2, 3, 4, 5.

Circuit diagram for a total current up to 10 Amps and voltage up to 20 Volts

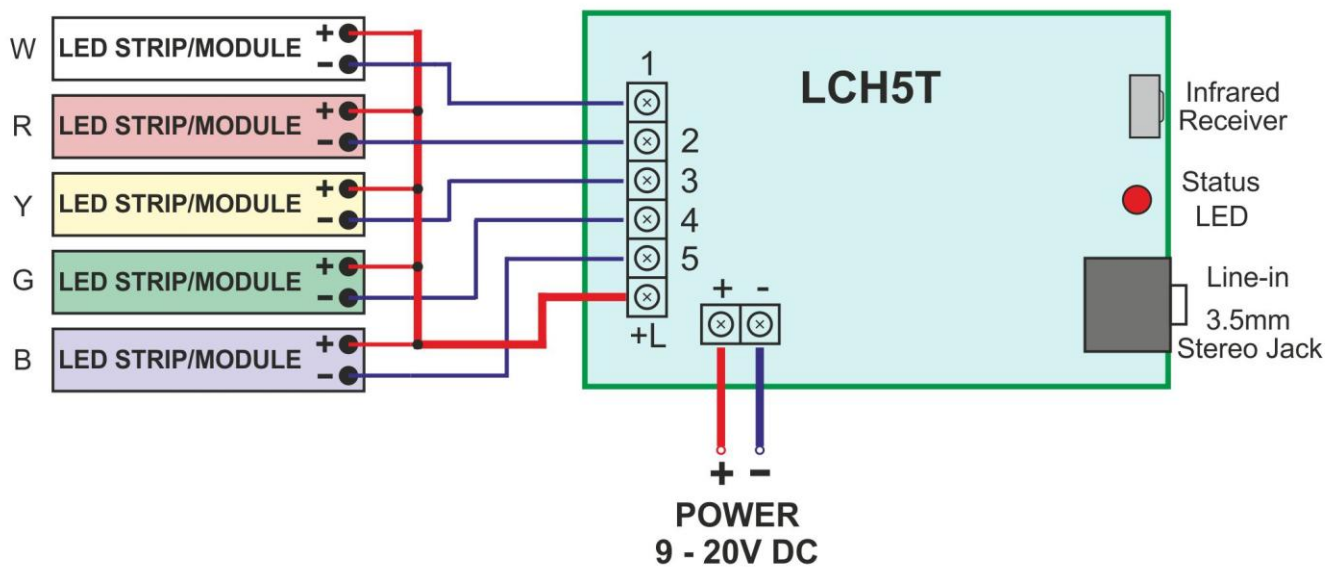

**Circuit diagram for a total current from 10 to 20 Amps
and voltage up to 28 Volts**

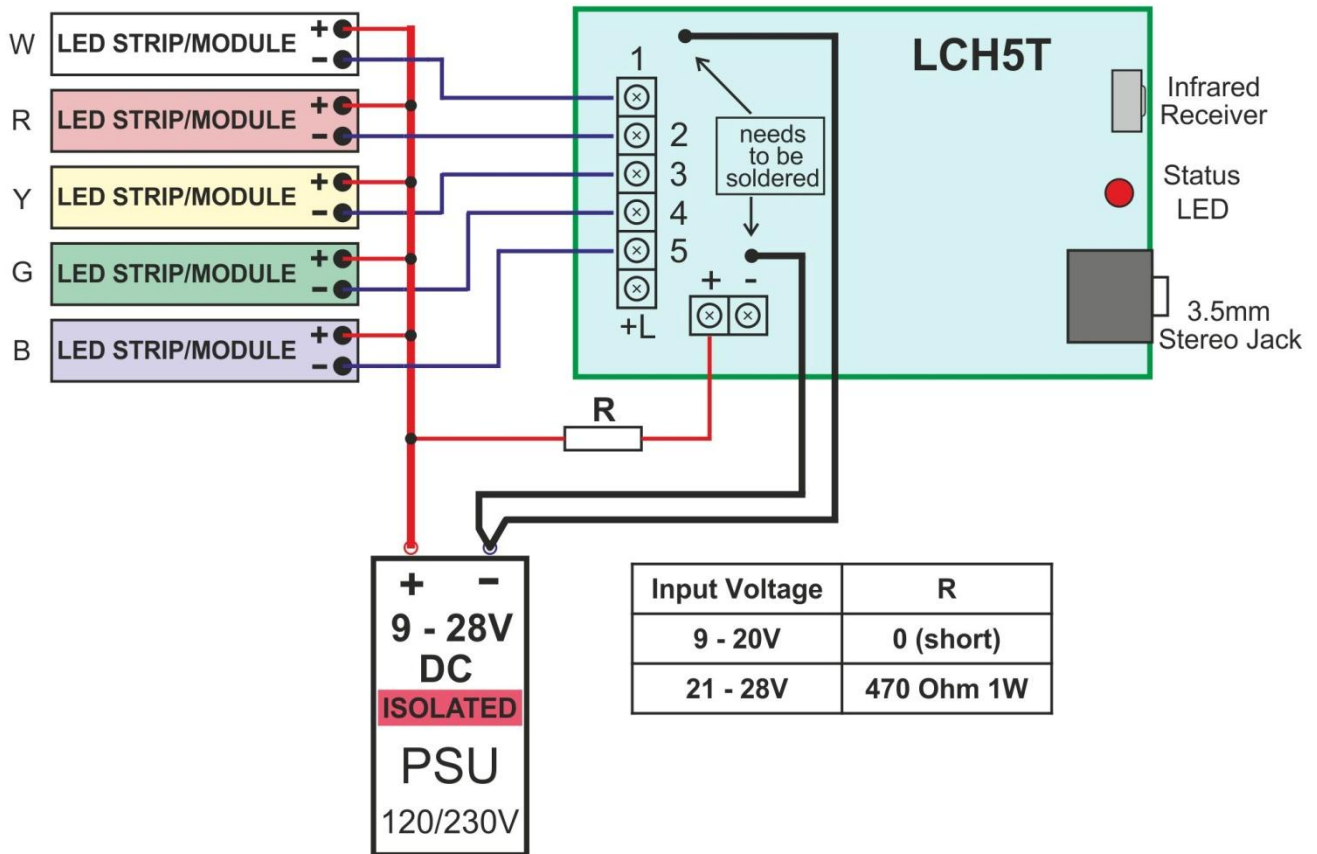

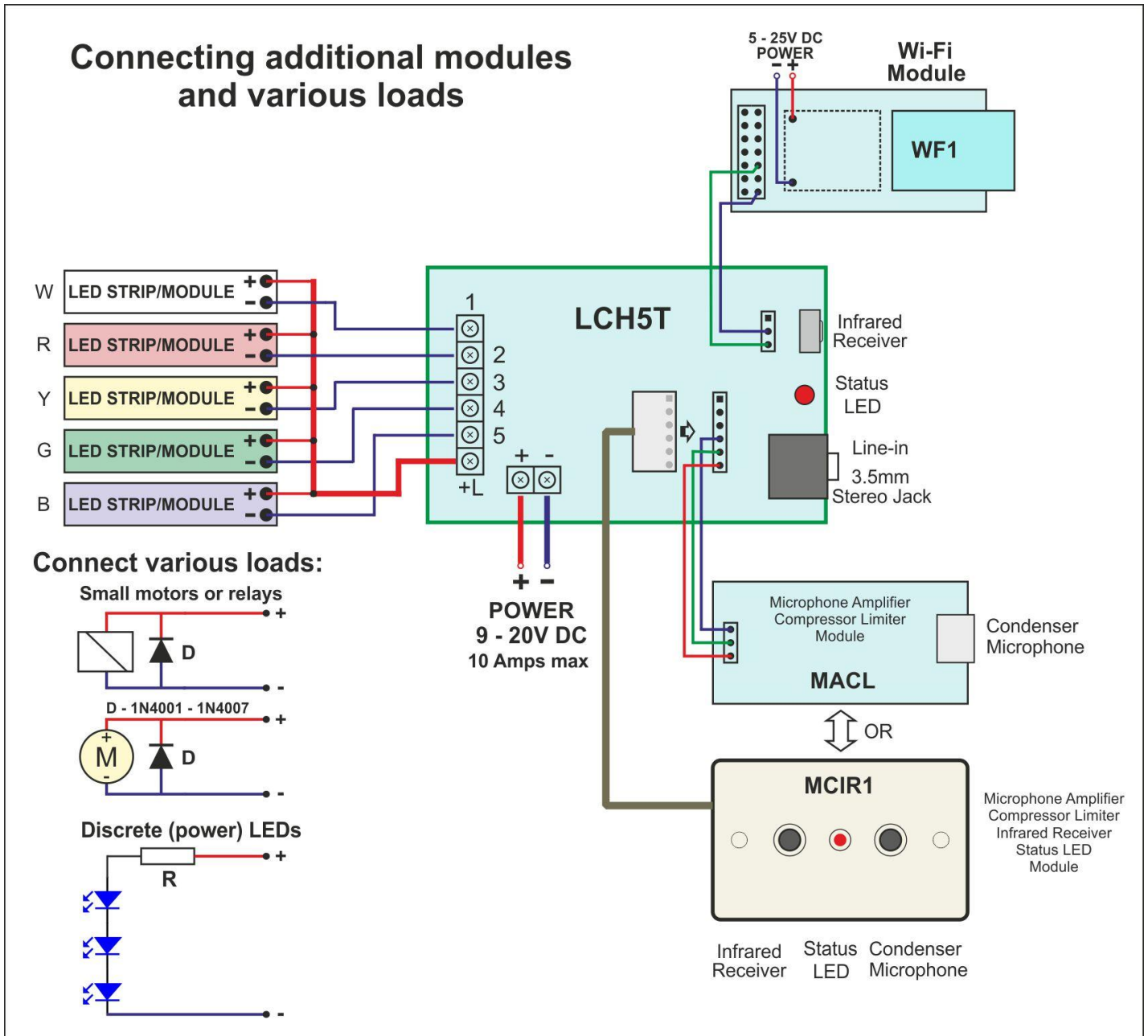

Warning:

- Outputs do **NOT** have protection from short circuit, overload or reverse voltage. Improper connection will lead to a damaged controller.
- LED must be connected by a series resistor limiting the current to nominal (in LED strips and modules is embedded).

2.0 Settings and operation

All operations and settings are performed by the included IR remote control.

2.1 Use of Stored Functions - Easy Switching Between Different Levels and Settings

Buttons **1, 2, 3, 4** and **5** are used for control of the relevant channels or as part of the ten buttons for stored functions. Switching is performed with the button . When buttons **1, 2, 3, 4** and **5** are used for channels control, STATUS LED flashes with short pulse (0.01s) and a long pause (2s).

You can quickly switch between the different saved light levels and Light Show settings with the use of the buttons **0, 1, 2, ..., 9**, and the levels will change smoothly until the new values are reached.

Table of the Factory Pre Stored Functions (You can change these settings)

Function button	Channel 1	Channel 2	Channel 3	Channel 4	Channel 5
0	Level 10%	Light Show without sound sync. - Program 1 - AUTO			
1	Level 100%	Level 30%	Level 100%	Level 30%	Level 100%
2	Level 20%	Level 100%	Level 20%	Level 100%	Level 20%
3	Level 10%	Level 10%	Level 100%	Level 10%	Level 10%
4	Level 10%	Level 40%	Level 40%	Level 100%	Level 40%
5	Level 0%	Level 100%	Level 100%	Level 100%	Level 100%
6	Inverse channel	Light Show with sound sync. - Program 1 - AUTO - Line-In			
7	Inverse channel	Light Show - Program 5 - Level meter  - Line-In			
8	Inverse channel	Light Show – Program 3 - Color Organ (PWM) - Line-In			
9	Level 100%	Level 100%	Level 100%	Level 100%	Level 100%

Note:

- **The functions are the highest priority.** No matter what mode is the controller using, the function button will activate the appropriate stored settings.
- The buttons **0, 6, 7, 8, 9** are always used for switching Functions.

2.2 Saving Functions

You can save the present levels and Light Show settings in the non-volatile memory by successively pressing and releasing the buttons **MENU** and one of **0, 1, 2, ..., 9**.

List of the settings are stored separately for each of the buttons from 0 to 9 :

- ✓ Levels of the channels
- ✓ ON/OFF Light Show

If Light Show is activated:

- ✓ The present program and whether it is with sound synchronization or not
- ✓ Audio input: Line-in or Microphone⁽¹⁾
- ✓ 4 channel Light Show (channels 2,3,4,5) or 3 channel (channels 3,4,5)
- ✓ ON/OFF inverse channel (channel 1)
- ✓ Level meter with AGC or without AGC - if activated programs 5 to 10 (level meter)

Note:

- When Light Show is activated, by pressing button  the last saved settings will be activated (by the sequence: **MENU** ,  , **3** to **6**), and not the last used settings by the function keys 0 to 9.
- Light Show can not be activated if it is disabled by the sequence: **MENU** ,  , **0**.
- You can find more info about these settings on section **5.13**.

3.0 Channels control

3.1 Setting the levels for the channels

Buttons **1, 2, 3, 4** and **5** are used for control of the relevant channels or as part of the ten buttons stored functions. Switching is performed with the button . When buttons **1, 2, 3, 4** and **5** are used for channels control, STATUS LED flashes with short pulse (0.01s) and a long pause (2s).

A single button system is used for regulating each channel and it is as follows:

- I. By pressing and releasing the button for specific channel the light's intensity is increasing.
 - II. After the next pressing and releasing it is fixed on the current level.
 - III. After pressing and releasing again - the light's intensity is decreasing.
 - IV. After the next pressing and releasing it is fixed on the current level.
- By repeating steps I - IV or part of them the required level can be reached.

For more precise adjustment the **+** and **-** buttons can be used. They regulate the last channel that was used, or the selected one by pressing and releasing the button **C** and the button for the specific channel.

Note: The options for controlling the device have the following priority:

1. Buttons for Functions
2. Light Show control buttons
3. Buttons for channels control

3.2 Adjusting the speed of smooth transitions when switching channels

The speed settings of smooth channels switching and speed settings in Light Show program 2 – “Smooth transitions sequence” is the same.

The adjustment can be made in the light show program 2 by **+** and **-** buttons.

You can find more info about these settings on section **5.9**.





3.3 Setting the channels in PWM or ON/OFF mode

You can switch certain channels in PWM or ON/OFF by turning on the necessary channels for ON/OFF mode and consistently press and release the **MENU**, , **1**. With this combination, the turned ON channels are stored in non-volatile memory with function ON/OFF, and the turned OFF channels with PWM. After such a change it is recommended the stored values and settings for buttons **0, 1, ..., 9** to be made again.

Note: Channels that are in ON/OFF mode do not work correctly in Light Show.

3.4 Table of General Settings

Settings changes can be made by successively pressing and releasing the following buttons:

MENU ,  , 1	Switching certain channels of PWM or ON / OFF can be made by turning ON the necessary channels for ON/OFF mode and consistently press and release the MENU ,  , 1 . With this combination, the turned ON channels are stored in non-volatile memory with function ON/OFF, and the turned OFF channels with PWM. After such a change it is advisable the stored values and settings 0, 1, ..., 9 to be set again.
MENU ,  , 7	After applying the supply voltage, the channels are OFF.
MENU ,  , 8	After applying the supply voltage, turns on the saved functions for button 9 .
MENU ,  , 0	Reset the user settings and return the original (factory) or just reboot. It activates STATUS LED - ON/OFF in 0.1 seconds, while awaiting confirmation with button + to return to initial (factory) settings, button - for RESET or another button to exit.

3.5 Hardware return to factory settings

- 1) Turn Power Off
- 2) Place jumper J5 pins 2 and 3 (Caution: incorrectly placed jumper on pins 1 and 2 can damage the controller)
- 3) Turn Power On
After 2-3 seconds or when STATUS LED turns on :
- 4) Turn Power Off
- 5) Remove jumper J5

Note: The data for function buttons 0 to 8 does not change. The function button 9 returns to the following settings:

Function button	Channel 1	Channel 2	Channel 3	Channel 4	Channel 5
9	Level 100%	Level 0%	Level 100%	Level 0%	Level 100%

4.0 Status LED Indication



For indication of the received infrared pulses and the current state of some features is used **STATUS LED**. When the buttons **1, 2, 3, 4** and **5** are used for the control of specific channel, **STATUS LED** flashes with short pulse (0.01s) and a long pause (2s). After pressing the button **MENU** the status LED is activated for 2 seconds (on/off in 0.1 sec.) as indication for waiting for the next button to be pressed.

5.0 Light Show Control and Settings

5.1 Turning ON/OFF Light Show



Turn ON/OFF Light Show by pressing button .

Note:

- When Light Show is activated by pressing button , the last saved settings will be activated (by the sequence: **MENU** , , **3** to **6**), instead of the last used settings by the function keys **0** to **9**.
- Light Show can not be activated if it is disabled by the sequence: **MENU** , , **0**.
- You can find more info about these settings on section **5.13**.

5.2 Switching programs

You can switch between programs with the following buttons:

-  next program (to 10)
-  previous program (to 1)

5.3 Switching between programs with/without sound control

The button **TEST** is used (if Light Show is activated) to switch between two groups of programs:

- programs with sound control - Color organ, Level meter, etc.
- programs with self patterns - chaser, moving light, etc.

5.4 Switching between audio inputs

You can switch between audio inputs with the following key sequence:





- **MENU** ,  - Line-in
- **MENU** ,  - Microphone⁽¹⁾

5.5 View the Maximum Levels for Channels in Light Show and Inverse Channel

You can visualise the present levels with key sequence: **C** ,  (Light Show must be switched OFF).

5.6 Setting the Maximum Levels for Channels in Light Show and Inverse Channel

You can equalize or adjust the light intensity for channels in Light Show, and set the maximum level for inverse channel by following these steps:

1. Turn off Light Show (button  or ).
2. Set the channels to desired levels (channel 1 for inverse channel, channels 2, 3, 4, 5 for Light Show) or visualise the present levels with key sequence: **C** ,  and adjust them.
3. Save the new levels by pressing and releasing the following buttons:
MENU , , **C** .

Note:

- Some colors LEDs are brighter than others. With this option, you have the ability to equalize brightness.
- This setting does not affect program 2 – “Smooth transitions sequence (PWM) without sound control”.
- For proper operation of Light Show program 3, the maximum level of channels should not be less than 15%.





5.7 Setting Audio Sensitivity AGC (Automatic gain control) for Color Organ

You can adjust sensitivity AGC for Color Organ separately for each frequency channel LF, MLF, MHF, HF in 4 levels. These settings are saved separately for each audio input - for 4 frequency channels on Line-In and for 4 on Microphone-In⁽¹⁾.

To adjust the sensitivity, the controller must be set on one of the two programs for Color Organ (program 2 or 3), and buttons 1 to 5 must be set for channels control (button  - status led flashes with short pulse 0.01s and a long pause 2s).









The selection of the channel that you want to adjust is made by pressing one of the buttons 2, 3, 4, 5 respectively for frequency channels LF, MLF, MHF, HF. By pressing one of the buttons 2 to 5, the present level of sensitivity is displayed on the output channels 2,3,4,5 as a level bar, where level 1 (which is the lowest sensitivity) will turn on channel 2 and level 4 (which is the highest sensitivity) will turn on channels 2,3,4 and 5. The selection of a channel is active until another channel is selected or the program is switched.

Table of Sensitivity level AGC

Sensitivity level AGC	Sensitivity displayed on the output channels 2, 3, 4, 5	Sensitivity level AGC	Sensitivity displayed on the output channels 2, 3, 4, 5
1 (lowest)		3	
2		4 (highest)	

The adjustment for the selected frequency channel is made by buttons + and - , and the levels are visualized on the output channels 2, 3, 4, 5. Pressing the button once serves only for visualization. Pressing it again serves for regulation. After the change of sensitivity it takes some time (3 – 15s) for activation of the new settings.

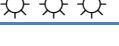
Table of the Factory Pre Stored Levels Sensitivity (You can change this settings)

Frequency channel	Button to select	Line-In factory pre stored level	Line-In level displayed on the output channels 2, 3, 4, 5	Microphone-In ⁽¹⁾ factory pre stored level	Microphone-In ⁽¹⁾ level displayed on the output channels 2, 3, 4, 5
LF	2	3		4	
MLF	3	3		4	
MHF	4	3		4	
HF	5	3		4	

5.8 Adjusting the speed in the programs without sound synchronization

You can adjust the speed of programs without sound synchronization by buttons + and - .

5.9 Adjusting the speed in program 2 – “Smooth transition sequence”

You can change the speed of the smooth transition in program 2 – “Smooth transition sequence (PWM) without sound control” with buttons + and - .

Note: This setting affects the speed of smooth transitions when switching channels in the "control channels" mode.

5.10 Setting Level Meter with / without AGC (Automatic gain control)

When one of program 5 to 10 is active (level meter) you can select the use of the AGC:

- Button 4 - turn On AGC (default)
- Button 5 - turn Off AGC

Table of input voltage when the AGC is turned off for the corresponding display of channels 2 to 5

Line-In input voltage (RMS)	Level displayed on the output channels 2, 3, 4, 5	
	Program 5 Level meter →	Program 6 Level meter ←
0.1V	☀ ● ● ●	● ● ● ☀
0.2V	☀ ☀ ● ●	● ● ☀ ☀
0.3V	☀ ☀ ☀ ●	● ☀ ☀ ☀
0.4V	☀ ☀ ☀ ☀	☀ ☀ ☀ ☀

There are two types of Light Show according to the number of channels used :

5.11 4 Channel Light Show (channels 2, 3, 4, 5)

In this mode **Channel 1** can be used for:

- **Inverse Channel.** When the channels 2, 3, 4 and 5 are off, channel 1 is switched smoothly to previously stored level. It works only for effects with 4 channels and synchronization with sound.
- Backlight with adjustable level 0-100%.

Table programs of 4 Channel Light Show

No	Programs with sound control	Programs without sound control
1	AUTO - automatic switching between programs 3 - 10, while at a low sound level - switches to program 2	AUTO - automatic switching between programs 3 - 10
2	Smooth transitions sequence (PWM) without sound control	
3	Color organ with smooth transitions (PWM)	Chaser →
4	Color organ classic	Chaser →, ←
5	Level meter →	Fill →, ←
6	Level meter ←	Chaser dark dot →
7	Level meter single dot →	Chaser ←
8	Level meter 2 dot ←	Fill ←, Chaser ←, etc.
9	Level meter with beat detection shift →	Chaser →, Fill ←, etc.
10	Level meter with beat detection shift ←	Fill →

5.12 3 Channel Light Show (channels 3, 4, 5)

In this mode **Channel 1** and **Channel 2** can be used for backlight with adjustable level 0-100%.

Note: The available programs that can be used are from 1 to 6 (view Table programs of 4 Channel Light Show).

Setting Audio Sensitivity AGC is not available, but the corresponding values from 4 Channel Light Show [channel MF= (MLF + MHF) /2] is used.





Inverse Channel is not available.

5.13 Table of General Settings for Light Show

Settings changes can be made by successively pressing and releasing the following buttons:

MENU , ► , 0	Disable Light Show
MENU , ► , 3	Enable 3 channel Light Show - used channels 3, 4 and 5
MENU , ► , 4	Enable 4 channel Light Show - used channels 2, 3, 4 and 5
MENU , ► , 5	Disable the use of inverse channel
MENU , ► , 6	Allow the use of channel 1 for inverse channel. When the channels 2, 3, 4 and 5 are off, channel 1 is switched smoothly to previously saved level. It works only for Light Show with 4 channels and synchronization with sound.
MENU , ► , 7	The range of low frequencies for color organ are set to 50 - 180Hz [DEFAULT]
MENU , ► , 8	The range of low frequencies for color organ are set to 50 - 250Hz. It is recommended when using speakers that do not reproduce low frequencies well.

6.0 Description of the remote control buttons

Button	Description	More info in section:
	Turns off all channels / turns on the saved functions for button 9 .	
MENU	Save the present levels and Light Show settings in the non-volatile memory by successively pressing and releasing the buttons MENU and one of 0, 1, 2, 3, 4, 5, 6, 7, 8, 9	2.2 3.4 5.13
TEST	Normal mode: Turns all channels ON. Light Show mode: ON/OFF the synchronization of sound and lighting effects (running lights-chaser OR color organ, level meter ...).	5.3
	You can choose between buttons 1, 2, 3, 4 and 5 to control the respective channels, or as a part of the ten buttons (0 - 9) for stored functions. When the buttons 1 - 5 are used for control of the respective channels, STATUS LED flashes with short pulse (0.01s) and a long pause (2s).	2.1 3.1 3.4
	ON/OFF Light Show.	5.1
	Next Light Show program (to 10) Light Show.	5.2 5.4
	Previous Light Show program (to 1) Light Show.	5.2 5.4
C	Selecting a particular channel to be precisely adjusted by + and - . Consecutively pressing and releasing C and one of 1, 2, 3, 4, 5 .	3.1
- +	Regulating the last used channel or the selected one when the Light Show is turned off. When the Light Show is turned ON and the PWM effect is active these buttons change the speed of the regulation of the channels and the PWM light effect. When the Light Show is on without synchronization with sound (chaser) these buttons regulate their speed.	3.1 5.7 5.8 5.9
1, 2, 3, 4, 5	Regulate or turns ON/OFF particular channel. ⁽²⁾	2.1 2.2 5.7 5.10
0, 1, 2, 3, 4, 5, 6, 7, 8, 9	Switch between the saved Functions. ⁽²⁾	2.1 2.2 3.1

NOTE 1: To use a microphone need an external module MACL .

NOTE 2: Buttons **1, 2, 3, 4** and **5** are used for control of the relevant channels or as part of the ten buttons (**0 - 9**) for stored functions. Switching is performed by the button . When they are used for channels control, STATUS LED flashes with short pause (0.01s) and a long pause (2s).

Arrangement of the buttons on the remote control:



Battery CR2025 (not included in kit)