

5 Channel LED Controller

HomLiCon LCH5LP-S

Application

- Control of groups LED and LED strips
- Control dynamic illuminated advertising signs
- Sound activated Light Show

Technical Specifications

LED sequencer mode number of Channels	4 or 5
Sound activated Light Show number of channels	5
Supply voltage	8 – 16V DC
Maximum output current per channel	2A
Maximum total output current	10A
Line-in Nominal level	0.3V RMS
Line-in Maximum level	1.5V RMS
Mic-in range of sound level (with an added module MACL - not included in the kit)	60 - 120 dB (with additional module) ⁽¹⁾
Current consumption	15mA
Ambient temperature	5 – 40°C

Controller Features

- ✓ LED sequencer mode suitable for use with advertisement lighting, party lights, etc.
- ✓ Ability to choose separate settings for speed and number of repetitions for each program.
- ✓ Sound activated Light Show
- ✓ Control all settings and functions with the IR remote control included in the kit.
- ✓ Activation of Light Show controlled by sound from microphone⁽¹⁾, Line-in or unsynchronized.
- ✓ Level Meter with / without AGC (Automatic gain control).
- ✓ Automatic or manual switching between different programs of Light Show.
- ✓ Possibility to select a mode to be activated when applied to the supply voltage..
- ✓ LED on each one of the channels connected to the microcontroller pins for indication and diagnostics.
- ✓ Power MOSFET for the output of each channel.

1.0 Wiring diagram and description

The supply voltage (8 – 16V DC) is connected to the terminal blocks marked + and - .
All + LED Strip / Module are connected together to the terminal blocks marked + L , and all - LED Strip / Module, respectively to terminals 1, 2, 3, 4, 5.

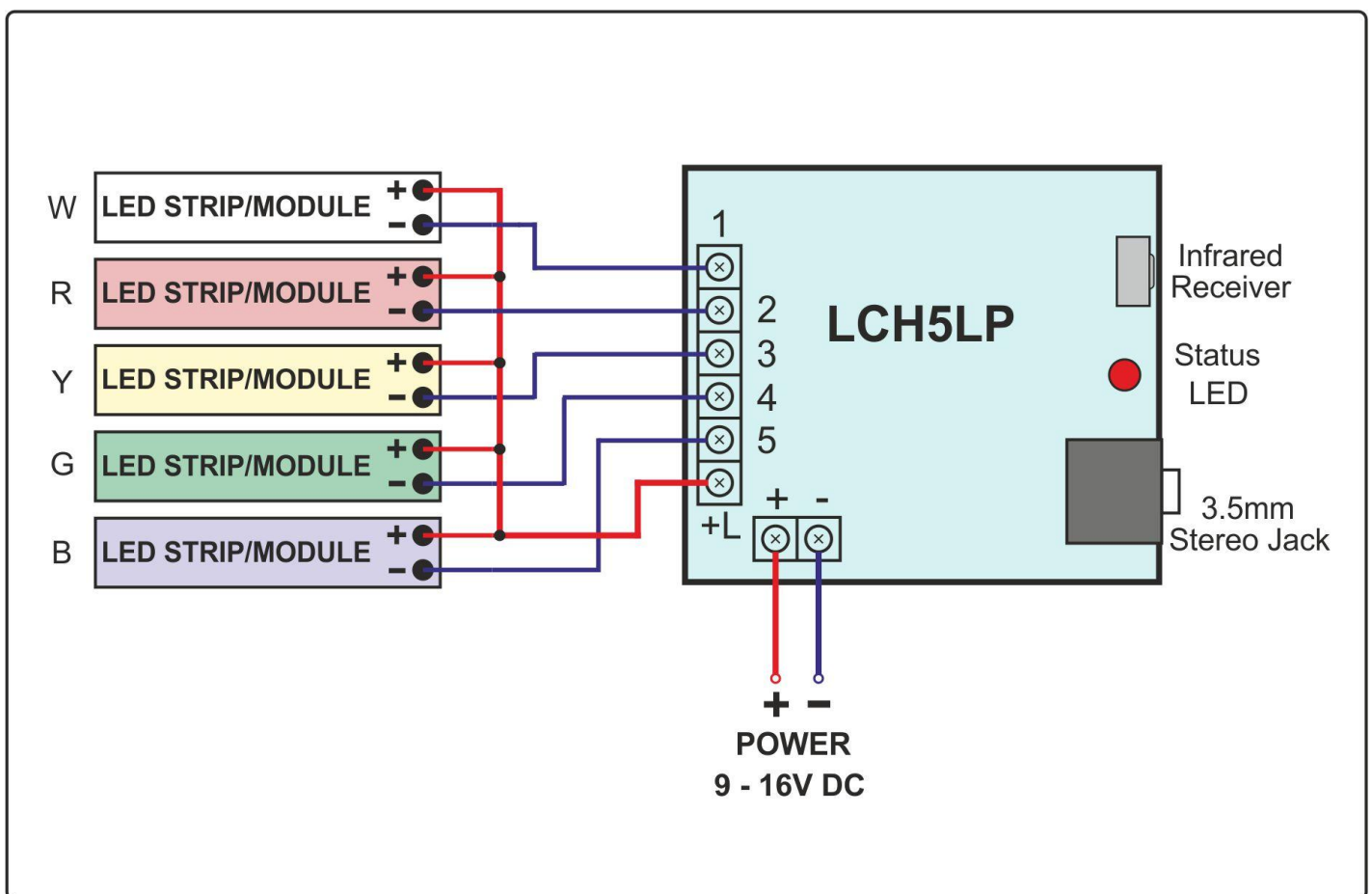

Connecting additional modules and various loads:

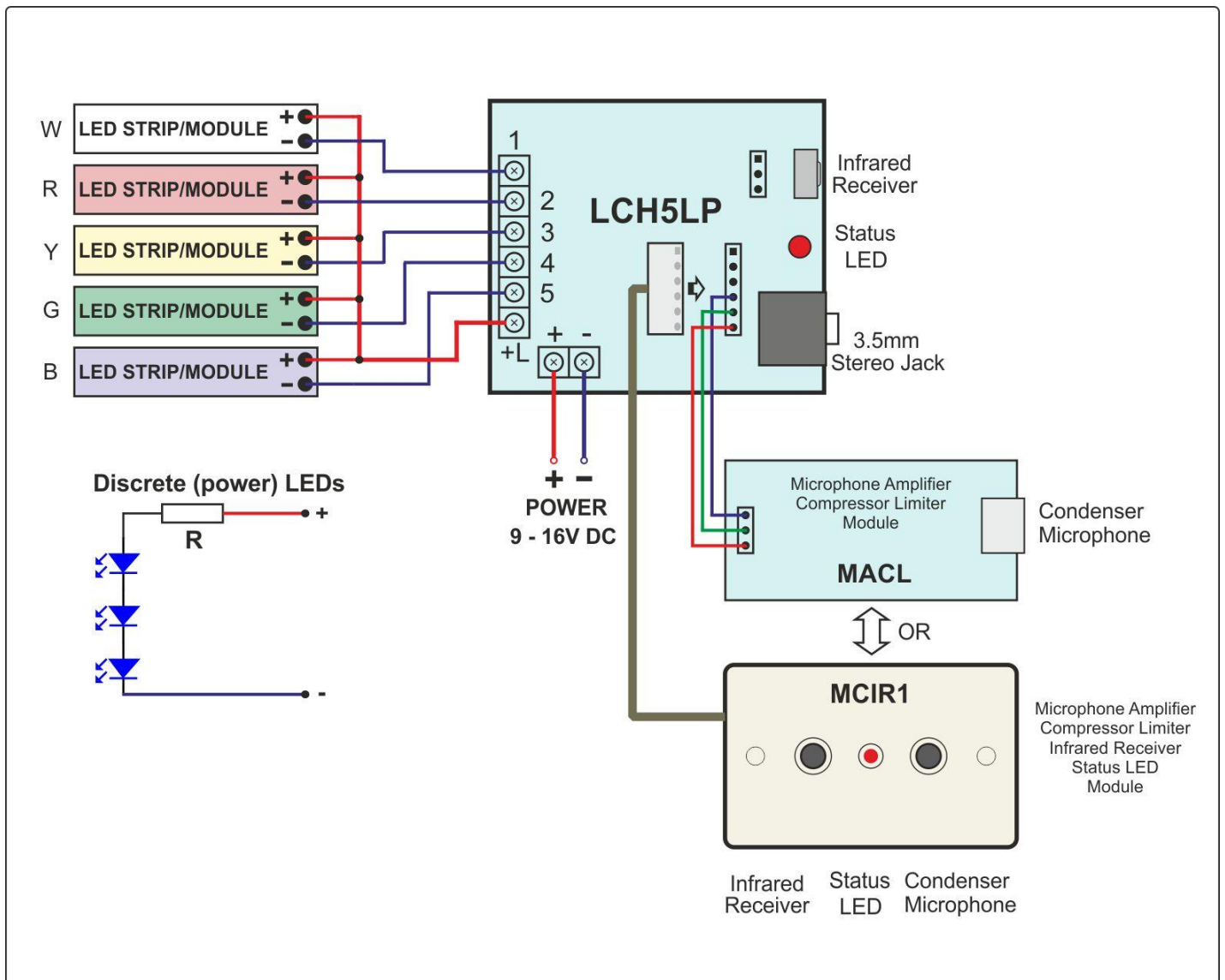

Warning:

- Outputs do **NOT** have protection from short circuit, overload or reverse voltage. Improper connection will lead to a damaged controller.
- LED must be connected by a series resistor limiting the current to nominal (in LED strips and modules is embedded).

2.0 LED Sequencer Mode - Control and Settings

All operations and settings are performed by the included IR remote control.

This mode includes the following programs:

Table programs of LED sequencer

No	Programs without sound control
1	AUTO - automatic switching between programs 2 - 9
2	Chaser →, ←
3	Fill →, ←
4	Fill →, Chaser →, ←
5	Chaser dark dot ←
6	Chaser ← Fill →
7	Chaser →
8	Fill →
9	Fill ←

2.1 Switching MODE - LED sequencer / Sound activated Light Show



The controller has two modes - LED sequencer and Sound activated Light Show. The switching between the two modes is done with one of the buttons:

- C** LED sequencer / Sound activated Light Show
-  LED sequencer / Sound activated Light Show

Note: Both buttons have the same function.



2.2 Switching programs

You can switch between programs with the following buttons:

-  next program (to 9)
-  previous program (to 2)
- 
 - activates program 1 – Auto
 - starts the first active of programs 2 – 9
 - saves the settings for programs 2 – 9
 - exit from standby mode



2.3 Program settings

After switching on the power, Program 1 - Auto is activated (at default setting). This program alternates sequentially active programs from 2 to 9, using the settings for each program made when it is individually selected.

Each of the programs 2 - 9, when selected (buttons  , ), has the option of individually adjusting the speed and number of repetitions with the following buttons:

- + , - adjusting the speed
 0 , 1 , ..., 9 number of repetitions in Program 1 - Auto. 0 - Disables the program.

Note:









- The settings are saved in the non-volatile memory only after pressing a button .
- With the button  you can restart the controller without saving the settings for the programs 2 – 9.

3.0 Sound activated Light Show - Control and Settings

All operations and settings are performed by the included IR remote control.



This mode includes the following programs:

Table programs of Sound activated Light Show

No	Programs with sound control
1	AUTO - automatic switching between programs 2 - 9
2	Level meter 
3	Level meter 
4	Level meter 2 dot 
5	Level meter 2 dot 
6	Level meter with beat detection shift 
7	Level meter with beat detection shift 
8	Level meter single dot 
9	Level meter single dot 

3.1 Switching MODE - LED sequencer / Sound activated Light Show



The controller has two modes - LED sequencer and Sound activated Light Show. The switching between the two modes is done with one of the buttons:

-  LED sequencer / Sound activated Light Show
-  LED sequencer / Sound activated Light Show

Note: Both buttons have the same function.

2.2 Switching programs

You can switch between programs with the following buttons:

-  next program (to 9)
-  previous program (to 2)
- 
 - activates program 1 – Auto
 - exit from standby mode

2.3 Setting Audio Sensitivity

When using a Line-in, you can choose between two sensitivity levels with the buttons:

- + high sensitivity
- low sensitivity

Note:

This setting is unavailable when using the microphone input. To use a Mic-in need an external module MACL .

2.4 Setting AGC (Automatic gain control)



You can select the use of the AGC (Automatic gain control) with the following buttons:

- 0 turn Off AGC
- 1 turn On AGC (default)

4.0 General Functions - Control and Settings

4.1 Switching MODE - LED sequencer / Sound activated Light Show

The controller has two modes - LED sequencer and Sound activated Light Show. The switching between the two modes is done with one of the buttons:

-  LED sequencer / Sound activated Light Show
-  LED sequencer / Sound activated Light Show

Note: Both buttons have the same function.

4.2 Power ON / Standby



- o Power ON / Standby
- o Reset if programs 2-9 settings are changed (not save changes)

4.3 Turns all channels ON

TEST Turns all channels ON / Light Show





4.4 Table of General Settings

Settings changes can be made by successively pressing and releasing the following buttons:

MENU , C , 1	Mic-in (to use a microphone need an external module MACL)
MENU , C , 3	Line-in (Default)
MENU , C , 4	Enable 4 channel "LED sequencer" - used channels 1, 2, 3 and 4
MENU , C , 5	Enable 5 channel "LED sequencer" (Default)
MENU , C , 7	"LED sequencer" is activated when the supply voltage is applied (Default)
MENU , C , 8	"Sound activated Light Show" is activated when the supply voltage is applied
MENU , C , 9	Save current settings for activate when the supply voltage is applied

Note: The interval between each button must not exceed 2 seconds.

6.0 Description of the remote control buttons

Button	Description	More info in section:
	Power ON / Standby	4.2
MENU	Save the general settings in the non-volatile memory by successively pressing and releasing the buttons MENU , C and one of 1, 3, 4, 5, 7, 8, 9	4.4
TEST	Turns all channels ON / Light Show	4.3
	Switching MODE - LED sequencer / Sound activated Light Show	2.1 3.1 4.1
	<ul style="list-style-type: none"> o activates program 1 – Auto o starts the first active of programs 2 – 9 (LED sequencer) o saves the settings for programs 2 – 9 (LED sequencer) o exit from standby mode 	2.2 3.2
	Next program (to 9)	2.2 3.2
	Previous program (to 2)	2.2 3.2
C	Switching MODE - LED sequencer / Sound activated Light Show	2.1 3.1 4.1
- +	<ul style="list-style-type: none"> o Adjusting the speed (LED sequencer) o Setting audio sensitivity (Sound activated Light Show) 	2.3 3.3
0, 1, 2, 3, 4, 5, 6, 7, 8, 9	Number of repetitions in Program 1 - Auto. 0 - Disables the program (LED sequencer)	2.3

Arrangement of the buttons on the remote control

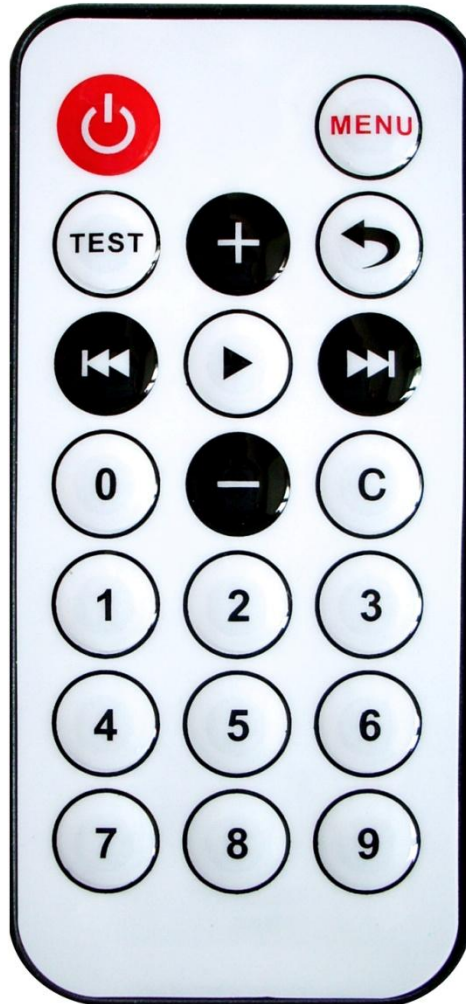

Battery CR2025 (not included in kit)