

## 3 Channel Multifunctional Controller

# HomLiCon LCH3HVL

### Application

- Control groups of lamps 120V/60Hz or 230V/50Hz
- Color Organ, Sound Activated Light Show, Light Sequencer, etc.
- Home Automation

Technical Specifications	
Number of Channels	3
Mains supply voltage	90 – 240 VAC
Maximum output power total (120 V mains voltage)	180 W (600 W)*
Maximum output power total (230 V mains voltage)	360 W (1200 W)*
Maximum output power per channel (120 V mains voltage)	60 W (200 W)*
Maximum output power per channel (230 V mains voltage)	120 W (400 W)*
Maximum output current per channel	0.5 A (1.6 A)*
Maximum output current total	1.5 A (4.8 A)*
Phase control steps for each channel	110
Supply voltage optically isolated part	12 VDC (9 – 12 VDC)
Current consumption	35 mA
Number of stored levels and settings	10
Color Organ bandwidth	LF 50 - 200 Hz , MLF 200 Hz - 1 kHz MHF 1 - 7 kHz , HF 7 - 14 kHz
Line-in nominal level (set standard / high sensitivity)	0.3 V RMS / 0.15 V RMS
Line-in maximum level	1.5 V RMS
Mic-in range of sound level (with an added module MACL - not included in the kit)	60 - 120 dB (with additional module) <sup>(1)</sup>
Ambient temperature	5 – 40°C

\* maximum values if a suitable heatsink is mounted on the triacs

---







## Controller Features

- ✓ Three main modes:
  - Color Organ, Sound Activated Light Show
  - Light Sequencer
  - Lighting
- ✓ Control of three channels with groups of the following types of lamps:
  - Incandescent lamps
  - Halogen lamps
  - Dimmable LED lamps / Dimmable LED strips
- ✓ Control of all settings and functions through the remote control included in the kit.
- ✓ Switch with a press of a button between the previously saved custom 10 groups, different levels for all channels or Light Show settings.
- ✓ Easy save of 10 custom groups, different levels for all channels or Light Show settings.
- ✓ Activation of Light Show controlled by sound from microphone<sup>(1)</sup>, Line-in or unsynchronized.
- ✓ Fully automatic Color Organ with digital division of the bandwidth in 3 range:  
LF 50 - 200Hz , MF 200Hz - 7kHz , HF 7 - 14kHz.
- ✓ Level Meter with / without AGC (Automatic gain control).
- ✓ Automatic or manual switching between different programs of Light Show.
- ✓ Adjust sensitivity AGC (Automatic gain control) for Color Organ separately for each frequency channel LF, MF, HF in 4 levels, saved separately for each audio input.
- ✓ Equalize or adjust the light intensity for channels in Light Show.
- ✓ Smooth change of light intensity when switching on or off each phase-controlled channel.
- ✓ Smooth change of light intensity for all channels to reach the preset levels when selecting one of the ten preset functions.
- ✓ Ability to set phase control for each channel or ON/OFF option.
- ✓ Ability to choose if the channels are off or a saved function is activated when the supply voltage is applied.
- ✓ LED on each one of the channels connected to the microcontroller pins for indication and diagnostics.
- ✓ Full optically isolated from mains voltage.
- ✓ Optron and TRIAC in the output of each channel.
- ✓ The controller can be tested via the onboard LEDs, being safely powered only by 12V.

## 1.0 Basic operations and wired diagram

### 1.1 Light Show basic operations



All operations and settings are performed by the included IR remote control.









Button	Description	More info in section:
	Turns <b>OFF</b> all channels / Turns <b>ON</b> the saved functions for button <b>9</b> .	2.1 2.2
	<b>ON / OFF</b> Light Show.	5.1
	Next Light Show program (to 10).	5.2 5.4 5.11
	Previous Light Show program (to 1).	5.2 5.4 5.11
<b>TEST</b>	Lighting mode: Turns all channels ON. Light Show mode: <b>ON / OFF</b> the synchronization of sound and light show (color organ, level meter OR Light Sequencer)	5.3
<b>MENU</b> , 	Line input (3.5mm stereo jack). The interval between buttons must not exceed 2 seconds.	5.4
<b>MENU</b> , 	Microphone <sup>(1)</sup> input. To use a microphone need an external module MACL. The interval between buttons must not exceed 2 seconds.	5.4

**Note 1:** Line-in audio signal must be from the Line-out of a player, computer (green jack) or smartphone. **Do not use a speaker output from amplifier or car audio.** Adjust (increase) the level of the player until the channels start to turn on.

**Note 2:** See section 5.0 for more details

#### Table programs of Light Show

Remote control buttons:  ON / OFF ,  Next program (to 10).,  Previous program (to 1)

No	Programs with sound control	Programs without sound control
1	AUTO - automatic switching between programs 3 - 8, while at a low sound level - switches to program 2	AUTO - automatic switching between programs 3 - 8
2	Smooth transitions sequence without sound control	
3	Color organ with smooth transitions	Chaser 
4	Color organ classic	Chaser 
5	Sound activated 1 - VU	Chaser  , 
6	Sound activated 2	Fill 
7	Sound activated 3	Fill 
8	Sound activated 4	Fill  , 
9	Sound Activated - Strobe chase	Strobe chase
10	Sound Activated - Strobe all	Strobe all

**Note:** Programs 9 and 10 are designed for use with dimmable LED lamps only.

**Table of the Factory Pre Stored Light Show Functions** (You can change these settings)

Button	Function	No Program	Signal input
0	Light Show without sound sync. (Light Sequencer) - <b>AUTO Program</b>	<i>Program 1</i>	–
4	Light Show – <b>Sound activated 2</b>	<i>Program 6</i>	Line-In
5	Light Show – <b>Color organ classic</b>	<i>Program 4</i>	Line-In
6	Light Show – <b>Sound activated 3</b>	<i>Program 7</i>	Line-In
7	Light Show – <b>Sound activated 1 - VU</b>	<i>Program 5</i>	Line-In
8	Light Show – <b>Color Organ smooth transitions</b>	<i>Program 3</i>	Line-In
9 	Light Show with sound sync.– <b>AUTO Program</b> – switch between programs 3 - 8, while at a low sound level - switch to program 2 (Smooth transitions sequence (PWM) without sound control}	<i>Program 1</i>	Line-In

**Note 1:** Button  Turns **OFF** all channels / Turns **ON** the saved functions for button **9**.

**Note 2:** See section 2.0 for more details

## 1.2 Wiring diagram and description

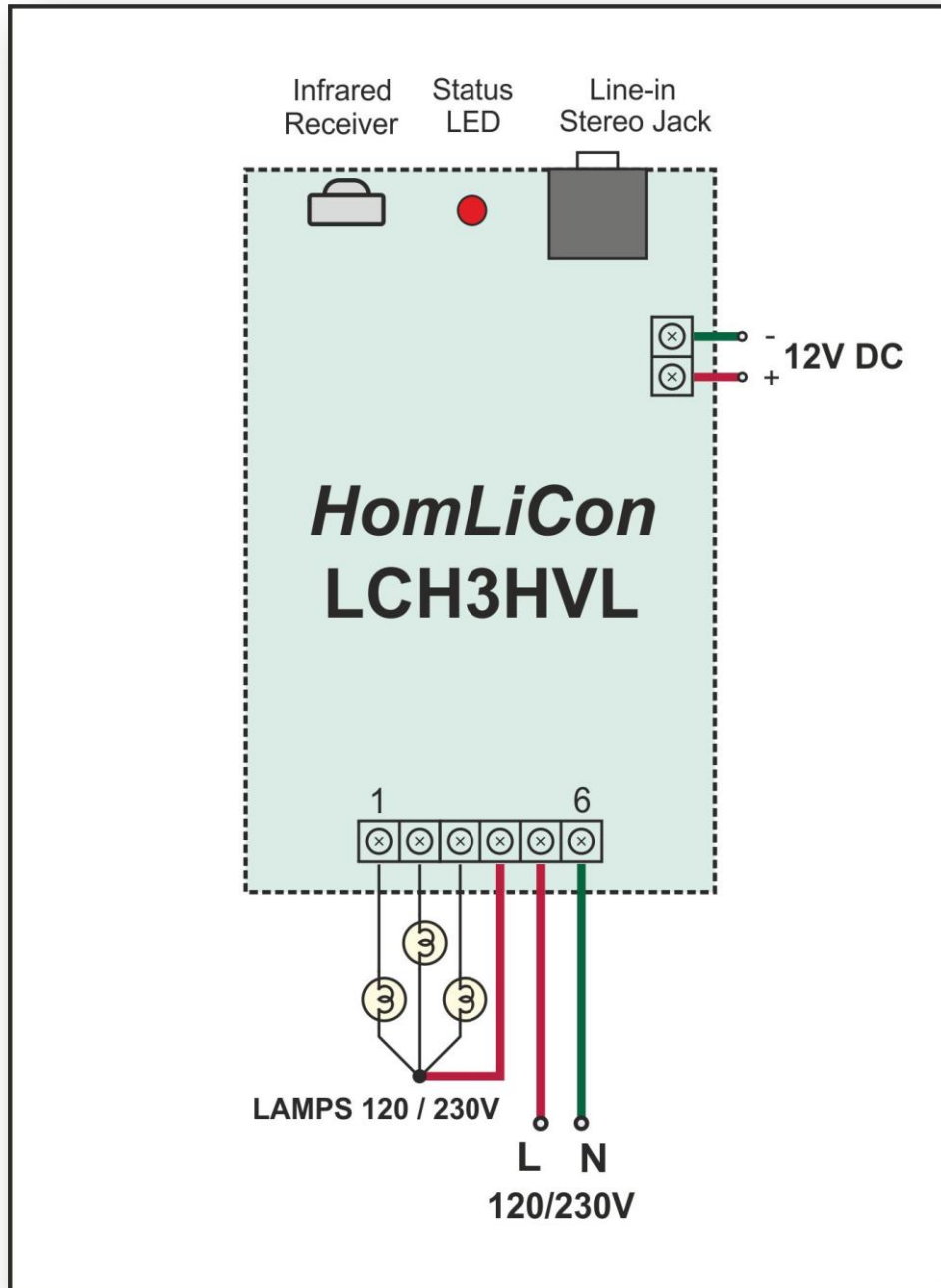

### Connecting modules and various loads

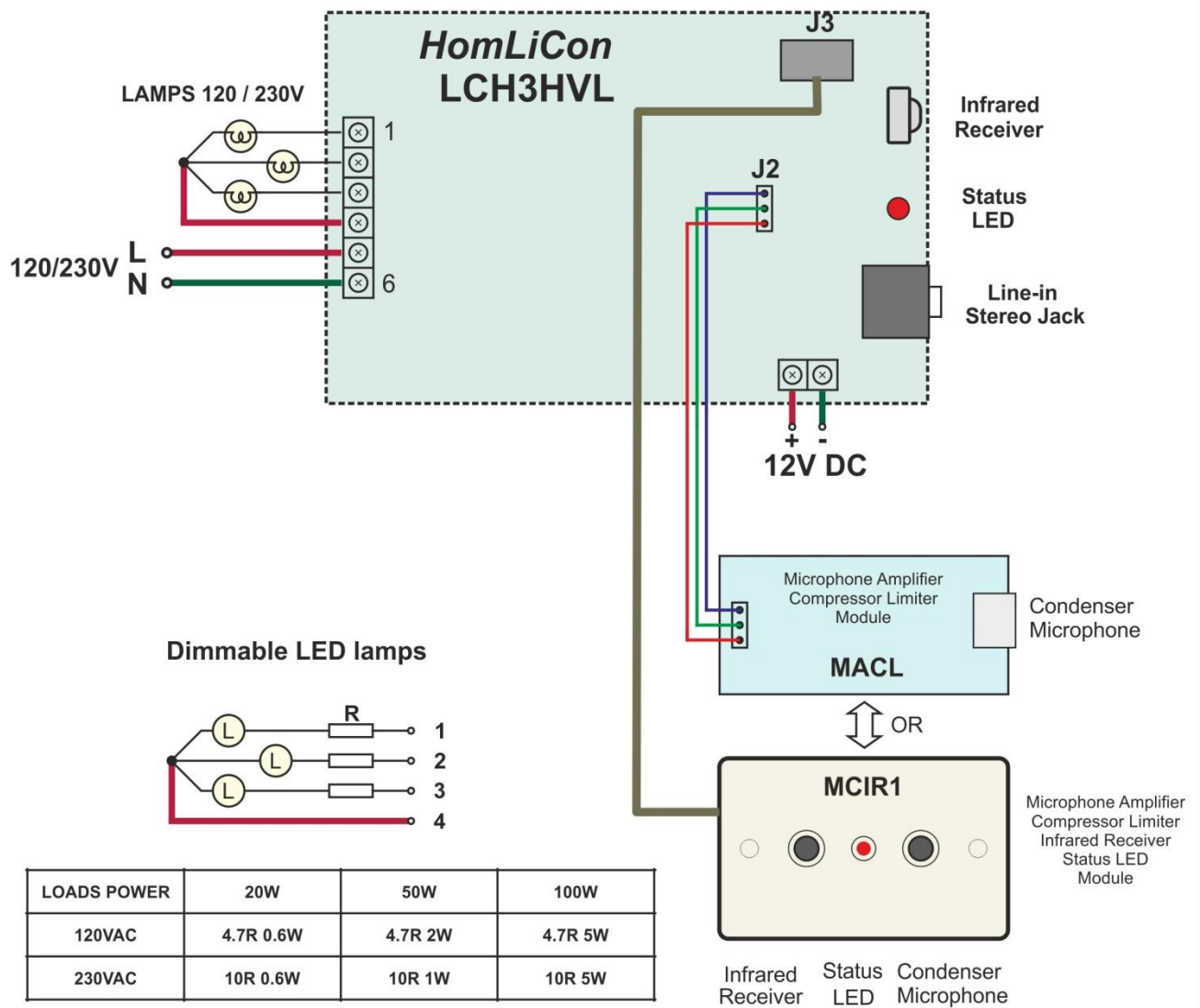

**Warning:**

**The device works with HIGH VOLTAGE !**

**Touching any of the elements of the device when plugged in can be life threatening.**

Outputs do NOT have protection from short circuit or overload.

Improper connection will lead to a damaged controller.

The controller can control lamps for 120V or 230V that allow dimming :

- Incandescent lamps
- Halogen lamps
- Dimmable LED lamps

**Using lamps that do not allow dimming may damage the lamp and controller.**

Dimmable LED lamps is recommended to be connected via a series resistor that limits the inrush current.

Line-in audio signal must be from the Line-out of a player, computer (green jack) or smartphone.

**Do not use a speaker output from amplifier or car audio.**

Adjust (increase) the level of the player until the channels start to turn on.

## 2.0 Settings and Operation

All operations and settings are performed by the included IR remote control.

### 2.1 Use of Stored Functions - Easy switching between different levels and settings

Buttons **1**, **2** and **3** are used for control of the corresponding channels or as part of the ten buttons for stored functions. Switching is performed with the button  - alternatively. When buttons **1**, **2** and **3** are used for channels control, STATUS LED flashes with short pulse (0.01s) and a long pause (2s).

You can quickly switch between the different saved light levels and Light Show settings with the use of the buttons **0**, **1**, **2**, ..., **9**, and the levels will change smoothly until the new values are reached.

**Table of the Factory Pre Stored Functions** (You can change these settings)

Button	Channel 1	Channel 2	Channel 3
<b>0</b>	Light Show without sound sync. (light sequencer) - Program 1 - <b>AUTO</b>		
<b>1</b>	Level 30%	Level 100%	Level 30%
<b>2</b>	Level 100%	Level 30%	Level 100%
<b>3</b>	Level 10%	Level 10%	Level 10%
<b>4</b>	Light Show - Program 6 - Sound activated 2 - Line-In		
<b>5</b>	Light Show - Program 4 - Color organ classic - Line-In		
<b>6</b>	Light Show - Program 7 - Sound activated 3 - Line-In		
<b>7</b>	Light Show - Program 5 - Sound activated 1 - VU - Line-In		
<b>8</b>	Light Show - Program 3 - Color organ with smooth transitions - Line-In		
<b>9</b>	Light Show - Program 1 - <b>AUTO</b> - Line-In		

#### Note:

- **The functions are the highest priority.** No matter what mode is the controller using, the function button will activate the appropriate stored settings.
- The buttons **0**, **4**, **5**, **6**, **7**, **8**, **9** are always used for switching Functions.
- Using the **C** button switches the controller to channel control mode via buttons 1, 2, 3.

### 2.2 Saving Functions

You can save the present levels and Light Show settings in the non-volatile memory by successively pressing and releasing the buttons **MENU** and one of **0**, **1**, **2**, ..., **9**.



List of the settings are stored separately for each of the buttons from 0 to 9 :

- ✓ Levels of the channels
- ✓ ON/OFF Light Show

If Light Show is activated:

- ✓ The present program
- ✓ Programs with or without sound synchronization
- ✓ Audio input: Line-in or Microphone<sup>(1)</sup>

#### Note:

- The Light Show settings are stored separately for each function button **0** to **9** and the button  for a total of 11 groups. Changing one setting will save all active at that time, only for the button .
- The settings for each function key **0** to **9** are saved only with the buttons **MENU**, **0** to **9**.
- Light Show can not be activated if it is disabled by the sequence: **MENU**, , **0**. You can find more info about these settings on section 5.13.



## 3.0 Lighting mode - Channels control

### 3.1 Setting the levels for the channels

The controller is in lighting mode when the light show is OFF.

Buttons **1** , **2** and **3** are used for control of the corresponding channels or as part of the ten buttons stored functions. Switching is performed with the button  - alternatively. When buttons **1** , **2** and **3** are used for channels control, STATUS LED flashes with short pulse (0.01s) and a long pause (2s). Using the **C** button switches the controller to channel control mode via buttons **1** , **2** , **3**.

**A single button system is used for regulating each channel and it is as follows:**

- I. By pressing and releasing the button for specific channel the light's intensity is increasing.
  - II. After the next pressing and releasing it is fixed on the current level.
  - III. After pressing and releasing again - the light's intensity is decreasing.
  - IV. After the next pressing and releasing it is fixed on the current level.
- By repeating steps I - IV or part of them the required level can be reached.

**For more precise adjustment the + and – buttons can be used. They regulate the last channel that was used, or the selected one by pressing and releasing the button **C** and the button for the specific channel.**

**Note:** The options for controlling the device have the following priority:

1. Buttons for Functions
2. Light Show control buttons
3. Buttons for channels control

### 3.2 Adjusting the speed of smooth transitions when switching channels

The speed settings of smooth channels switching and speed settings in Light Show program 2 – “Smooth transitions sequence” is the same.

The adjustment can be made in the light show program 2 by **+** and **-** buttons.

You can find more info about these settings on section **5.9**.





### 3.3 Setting the channels in PHASE CONTROL or ON/OFF mode

You can switch certain channels in phase control (method for power limiting) or ON/OFF by turning ON the necessary channels for ON/OFF mode and sequentially press and release the **MENU** ,  , **1** . With this combination, the turned ON channels are stored in non-volatile memory with function ON/OFF, and the turned OFF channels with phase control. After such a change it is recommended the stored values and settings for buttons **0** , **1** , ..., **9** to be made again.

**Note:** Channels that are in ON/OFF mode do not work correctly in Light Show.

### 3.4 Table of General Settings

Settings changes can be made by successively pressing and releasing the following buttons:

<b>MENU</b> ,  , <b>1</b>	Switching certain channels of <b>phase control</b> or ON / OFF can be made by turning ON the necessary channels for ON/OFF mode and consistently press and release the <b>MENU</b> ,  , <b>1</b> . With this combination, the turned ON channels are stored in non-volatile memory with function ON/OFF, and the turned OFF channels with PWM. After such a change it is advisable the stored values and settings 0, 1, ..., 9 to be set again.
<b>MENU</b> ,  , <b>7</b>	After applying the supply voltage, the channels are OFF.
<b>MENU</b> ,  , <b>8</b>	After applying the supply voltage, turns on the saved functions for button <b>9</b> .
<b>MENU</b> ,  , <b>0</b>	Reset the user settings and return the original (factory) settings. It activates <i>STATUS LED - ON/OFF</i> in 0.1 seconds, while awaiting confirmation with button: <b>5</b> to return to initial (factory) settings for mains voltage <b>230V 50Hz</b> (EU, Russia, ...) <b>6</b> to return to initial (factory) settings for mains voltage <b>120V 60Hz</b> (USA, Canada, ...) <b>1</b> to reset only without any changes <b>another button to exit</b>

**Note:** The interval between each button must not exceed 2 seconds.

### 3.5 Hardware return to factory settings

**Switch OFF the mains voltage 120 - 230V to perform the specified sequence.**

- 1) Turn OFF the 12V power supply.
- 2) Place jumper J5 pins 2 and 3 (**Note:** incorrectly placed jumper on pins 1 and 2 can damage the controller)
- 3) Turn ON the 12V power supply.  
After 2-3 seconds or when STATUS LED turns on :
- 4) Turn OFF the 12V power supply.
- 5) Remove jumper J5

**Note:** Hardware return to factory settings always return settings for mains voltage 120V 60Hz (USA, Canada, ...). If your mains voltage is 230V 50Hz (EU, Russia, ...) necessary to execute the sequence of table 3.4 - **MENU** ,  , **0** , **5** .

## 4.0 Status LED Indication





For indication of the received infrared pulses and the current state of some features is used **STATUS LED**. When the buttons **1**, **2** and **3** are used for the control of specific channel, **STATUS LED** flashes with short pulse (0.01s) and a long pause (2s). After pressing the button **MENU** the status LED is activated for 2 seconds (on/off in 0.1 sec.) as indication for waiting for the next button to be pressed.

## 5.0 Light Show Control and Settings

### 5.1 Turning ON/OFF Light Show



Turn ON/OFF Light Show by pressing button .

#### Note:

- When Light Show is activated by pressing button , the last saved settings will be activated instead of the last used settings by the function keys **0** to **9**. The Light Show settings are stored separately for each function button **0** to **9** and the button  for a total of 11 groups. Changing one setting will save all active at that time, only for the button .
- Light Show can not be activated if it is disabled by the sequence: **MENU** ,  , **0**.
- You can find more info about these settings on section **5.13**.

### 5.2 Switching programs

You can switch between programs with the following buttons:

-  next program (to 10)
-  previous program (to 1)

### 5.3 Switching between programs with/without sound control

The button **TEST** is used (if Light Show is activated) to switch between two groups of programs:

- programs with sound control - Color organ, Level meter, etc.
- programs with self patterns - chaser, moving light, etc.

### 5.4 Switching between audio inputs

You can switch between audio inputs with the following key sequence:

- **MENU** ,  - Line-in
- **MENU** ,  - Microphone<sup>(1)</sup>

The interval between each button must not exceed 2 seconds.

### 5.5 Setting Line-in Audio Sensitivity

When using a Line-in, you can choose between two sensitivity levels with the buttons:

- Standard sensitivity (default)
- + High sensitivity

To adjust the sensitivity of the line input, the controller must be set to one of the Light Show programs with sound control (programs 3 to 10 - Color organ, Level meter, etc.).

First pressing one of the + or - buttons only serves to indicate the current sensitivity state for a period of 2 seconds:

Standard sensitivity - channel 2 ON (green)  
High sensitivity - channel 3 ON (blue)

**Note 1:** Press the **C** button before adjusting the sensitivity if you have already made other settings (eg those in section 5.7).

**Note 2:** This setting is unavailable when using the microphone input.





## 5.6 Setting maximum brightness levels for channels in Light Show

Some colors LEDs are brighter than others. With this option, you have the ability to equalize brightness. You can equalize or adjust the light intensity for channels in Light Show by following these steps:

### 5.6.1 View maximum brightness levels for channels in Light Show

You can visualise the present levels with key sequence: **C** ,  (Light Show must be switched OFF).

### 5.6.2 Setting maximum brightness levels for channels in Light Show

1. Turn OFF Light Show ( button  or  ).
2. Set the channels to desired levels(See section 3.1) or visualise the present levels with key sequence: **C** ,  and adjust them.
3. Save the new levels by pressing and releasing the following buttons:  
**MENU** ,  , **C** .

#### Note:

- Some colors lamps are brighter than others. With this option, you have the ability to equalize brightness.
- Use this option only if necessary.
- This setting does not affect program 2 – “Smooth transitions sequence (PWM) without sound control”.
- For proper operation of Light Show program 3, the maximum level of channels should not be less than 15%.

## 5.7 Setting Audio Sensitivity AGC (Automatic gain control) for Color Organ

You can adjust sensitivity AGC for Color Organ separately for each frequency channel LF, MF, HF in 4 levels. These settings are saved separately for each audio input - for 3 frequency channels on Line-In and for 3 on Microphone-In<sup>(1)</sup>.

To adjust the sensitivity, the controller must be set on one of the two programs for Color Organ (program 3 or 4 – Table 5.11), and buttons 1 to 3 must be set for channels control (button  - status led flashes with short pulse 0.01s and a long pause 2s).

The selection of the channel that you want to adjust is made by pressing one of the buttons 1, 2, 3 respectively for frequency channels LF, MF, HF. By pressing one of the buttons 1 to 3, the present level of sensitivity is displayed on the output channels as a level bar, where level 1 (which is the lowest sensitivity) will turn off all channel and level 4 ( which is the highest sensitivity) will turn on channels 1, 2, 3. The selection of a channel is active until another channel is selected or the program is switched.

Table of Sensitivity level AGC

Sensitivity level AGC	Sensitivity displayed on the output channels 1, 2, 3	Sensitivity level AGC	Sensitivity displayed on the output channels 1, 2, 3
1 (lowest)	● ● ●	3	☀ ☀ ●
2	☀ ● ●	4 (highest)	☀ ☀ ☀

The adjustment for the selected frequency channel is made by buttons + and - , and the levels are visualized on the output channels 1, 2, 3. Pressing the button once serves only for visualization. Pressing it again serves for regulation. After the change of sensitivity it takes some time (3 – 15s) for activation of the new settings.

**Table of the Factory Pre Stored Levels Sensitivity** (You can change this settings)

Frequency channel	Button to select	Line-In factory pre stored level	Line-In level displayed on the output channels 2, 3, 4, 5	Microphone-In <sup>(1)</sup> factory pre stored level	Microphone-In <sup>(1)</sup> level displayed on the output channels 2, 3, 4, 5
<b>LF</b>	1	3	☀ ☀ ●	4	☀ ☀ ☀
<b>MF</b>	2	3	☀ ☀ ●	4	☀ ☀ ☀
<b>HF</b>	3	3	☀ ☀ ●	4	☀ ☀ ☀

## 5.8 Adjusting the speed in the programs without sound synchronization

You can adjust the speed of programs without sound synchronization by buttons **+** and **-**.

**Note:** Three separate speeds are stored: for programs 3 – 8, for programs 9 and 10, for program 2 and lighting mode

## 5.9 Adjusting the speed in program 2 – “Smooth transition sequence”

You can change the speed of the smooth transition in program 2 – “Smooth transition sequence (PWM) without sound control” with buttons **+** and **-**.

**Note:** This setting affects the speed of smooth transitions when switching channels in the Lighting mode.

Three separate speeds are stored:

- for programs 3 - 8
- for programs 9 and 10
- for program 2 and lighting mode

## 5.10 Determining the optimal voltage of the audio signal -

Level meter without AGC (Automatic gain control)

To determine the optimal audio signal level (Line-In only), you can temporarily turn off the AGC. When program 5 is active (Sound activated 1 - VU) you can select the use of the AGC:

- Button **1** - turn ON AGC (default)
- Button **2** - turn OFF AGC

**Table of input voltage when the AGC is turned OFF for the corresponding display of channels 1, 2, 3**

Line-In input voltage (RMS)	Level displayed on the output channels 1, 2, 3	
Standard / High sensitivity	Program 5 - Sound activated 1 - VU	
<b>0.2V / 0.1V</b>	☀ ● ●	Optimal level
<b>0.4V / 0.2V</b>	☀ ☀ ●	Optimal level
<b>0.5V / 0.25V</b>	☀ ☀ ☀	High level

**The level is optimal when channel 1 is ON and channel 2 is flashing.**

**Note:**

1. This setting will not be saved. Exit from program 5 automatically turns ON the AGC.
2. Program 5 and switched OFF AGC can be saved to a function key (see section 2.2).
3. AGC can be turned OFF when MIC-IN is active. The voltages for switching ON channels 1 - 3 are respectively: 0.5V, 1V, 1.25V.

## 5.11 Programs of Light Show

**Table programs of Light Show**

No	Programs with sound control	Programs without sound control
1	AUTO - automatic switching between programs 3 - 8, while at a low sound level - switches to program 2	AUTO - automatic switching between programs 3 - 8
2	Smooth transitions sequence without sound control	
3	Color organ with smooth transitions	Chaser →
4	Color organ classic	Chaser ←
5	Sound activated 1 - VU	Chaser →, ←
6	Sound activated 2	Fill →
7	Sound activated 3	Fill ←
8	Sound activated 4	Fill →, ←
9	Sound Activated - Strobe chase	Strobe chase
10	Sound Activated - Strobe all	Strobe all

**Note:** Programs 9 and 10 are designed for use with dimmable LED lamps only.

## 5.12 Pulses duration at the outputs

For two groups of programs it is possible to set the duration of the pulses in the outputs of the channels:

### 1. Color organ - programs 3 and 4

When program 3 or 4 is active, you can set the pulses duration with button **C** alternatively - normal / extended.

### 2. Strobe - programs 9 and 10

When program 9 or 10 is active, you can set the pulses duration with button **C** alternatively - normal / short.





## 5.13 Table of General Settings for Light Show

Settings changes can be made by successively pressing and releasing the following buttons:

<b>MENU</b> , <b>▶</b> , <b>0</b>	Disable Light Show
<b>MENU</b> , <b>▶</b> , <b>4</b>	Enable Light Show
<b>MENU</b> , <b>▶</b> , <b>7</b>	The range of low frequencies for color organ are set to 50 - 200Hz [DEFAULT]
<b>MENU</b> , <b>▶</b> , <b>8</b>	The range of low frequencies for color organ are set to 50 - 250Hz.

**Note:** The interval between each button must not exceed 2 seconds.

## 6.0 Description of the remote control buttons

Button	Description	More info in section:
	Turns off all channels / turns on the saved functions for button <b>9</b> .	
<b>MENU</b>	Save the present levels and Light Show settings in the non-volatile memory by successively pressing and releasing the buttons MENU and one of <b>0, 1, 2, 3, 4, 5, 6, 7, 8, 9</b>	2.2 3.4 5.13
<b>TEST</b>	<b>Lighting mode:</b> Turns all channels ON. <b>Light Show mode:</b> ON / OFF the synchronization of sound and Light Show (Color organ, Level meter <b>OR</b> Light Sequencer)	5.3
	You can choose between buttons <b>1, 2</b> and <b>3</b> to control the corresponding channels, or as a part of the ten buttons ( <b>0 - 9</b> ) for stored functions. When the buttons <b>1 - 3</b> are used for channels control, STATUS LED flashes with short pulse (0.01s) and a long pause (2s).	2.1 3.1 3.4
	ON/OFF Light Show.	5.1
	Next Light Show program (to 10)	5.2 5.4
	Previous Light Show program (to 1)	5.2 5.4
<b>C</b>	Select a channel to be precisely tuned with <b>+</b> and <b>-</b> . Sequentially press and release <b>.C</b> and one of <b>1, 2, 3</b>	3.1
	Light Show - set the duration of the pulses in the outputs normal / extended.	5.12
<b>- +</b>	Regulating the last used channel or the selected one when the Light Show is turned off. When the Light Show is turned ON and the program 2 is active these buttons change the speed of the regulation of the channels. When the Light Show is ON without synchronization with sound (chaser) these buttons regulate their speed.	3.1 5.7 5.8 5.9
<b>1, 2, 3</b>	Regulate or turns ON/OFF particular channel. <sup>(2)</sup>	2.1 2.2 5.7 5.10
<b>0, 1, 2, 3, 4, 5, 6, 7, 8, 9</b>	Switch between the saved Functions. <sup>(2)</sup>	2.1 2.2 3.1

**NOTE 1:** To use a microphone need an external module MACL .

**NOTE 2:** Buttons **1, 2** and **3** are used for control of the relevant channels or as part of the ten buttons (**0 - 9**) for stored functions. Switching is performed by the button . When they are used for channels control, STATUS LED flashes with short pause (0.01s) and a long pause (2s).

Arrangement of the buttons on the remote control:

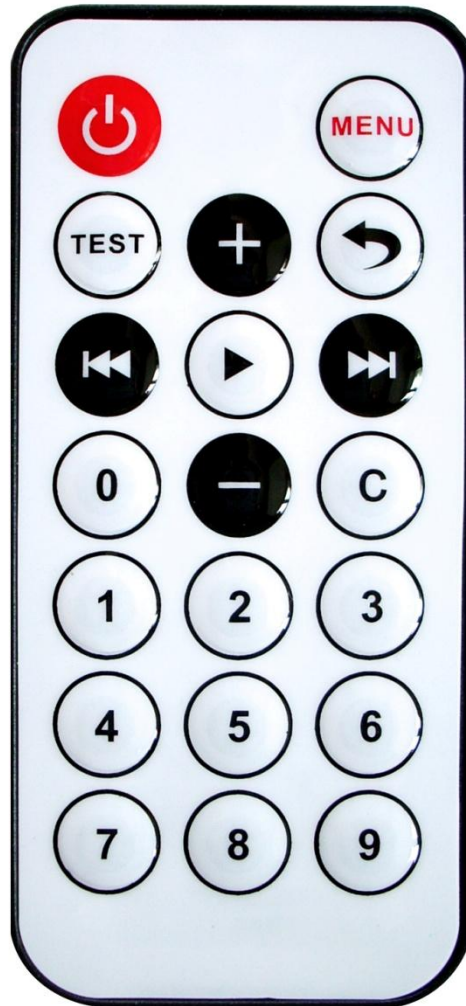

Battery CR2025 (not included in kit)